

IEG1-33598-5-V

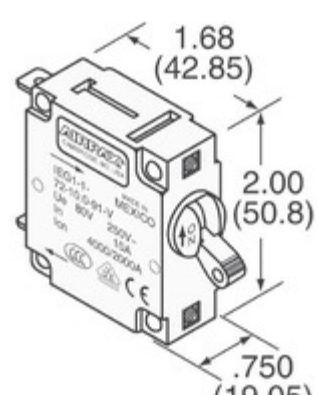

Obrázky jsou pouze orientační.
Podrobné informace o produktu naleznete v části Technické údaje produktu.

Koupit IEG1-33598-5-V s důvěrou od Component-World.HK, 1 rok záruka



Part Number: [IEG1-33598-5-V](#)

Výrobce: [Sensata Technologies, Airpax](#)

Popis: CIR BRKR MAG-HYDR LEVER

Datový list: [IEG, IUG, JEG, CEG, LEG Series Datasheet](#)

RoHS Status: Bez olova / V souladu RoHS

Ship From: Hong Kong

Shipment Way: DHL/Fedex/TNT/UPS/EMS

[Request For Quotation](#)













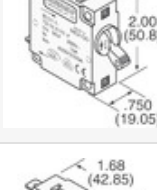
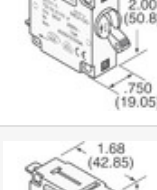
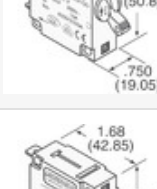
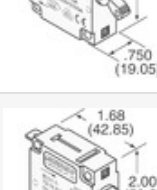
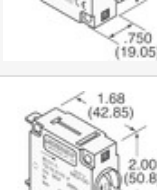

PARAMETR PRODUKTU

Part Number	IEG1-33598-5-V	Výrobce	Sensata Technologies, Airpax
Popis	CIR BRKR MAG-HYDR LEVER	Stav volného vedení / RoHS	Bez olova / V souladu RoHS
Dostupné množství	3106 pcs	Datový list	IAG,IUG,JEG,CEG,LEG Series Datasheet
Kategorie	Ochrana obvodu	Série	IEG
Počet pólů	1	Typ montáže	Panel Mount
Úroveň citlivosti na vlhkost (MSL)	1 (Unlimited)	Výrobní standardní doba výroby	6 Weeks
Stav volného vedení / RoHS	Lead free / RoHS Compliant	Osvětlení napětí (nominální)	-
Osvětlení	-	Jmenovitá hodnota proudu	-
Breaker Typ	Magnetic (Hydraulic Delay)	Pohon Type	Lever

Component-World.com je spolehlivý distributor elektronických součástek. Specializujeme se na všechny elektronické komponenty řady Sensata Technologies, Airpax. Máme 3106 kusy Sensata Technologies, Airpax IEG1-33598-5-V na skladě dostupných. Vyžádejte si citát z distributora součástí elektroniky na Component-World.com, náš prodejní tým vás bude kontaktovat do 24 hodin.

RFQ Email: info@Components-World.com

SOUVISEJÍCÍ PRODUKTY

	Část#: IEG1-33568-25-V	Výrobci: Sensata Technologies, Airpax	Dotaz
	Popis: CIR BRKR MAG-HYDR LEVER		
	Část#: IEG1-33568-30-V	Výrobci: Sensata Technologies, Airpax	Dotaz
	Popis: CIR BRKR MAG-HYDR LEVER		
	Část#: IEG1-33783-1-V	Výrobci: Sensata Technologies, Airpax	Dotaz
	Popis: CIR BRKR MAG-HYDR LEVER		
	Část#: IEG1-34165-R75-V	Výrobci: Sensata Technologies, Airpax	Dotaz
	Popis: CIRCUIT BREAKER MAG-HYDR LEVER		
	Část#: IEG1-34411-1-V	Výrobci: Sensata Technologies, Airpax	Dotaz
	Popis: CIR BRKR MAG-HYDR LEVER		
	Část#: IEG1-32994-4-V	Výrobci: Sensata Technologies, Airpax	Dotaz
	Popis: CIR BRKR MAG-HYDR LEVER		
	Část#: IEG1-34125-2-V	Výrobci: Sensata Technologies, Airpax	Dotaz
	Popis: CIR BRKR MAG-HYDR LEVER		
	Část#: IEG1-34125-3-V	Výrobci: Sensata Technologies, Airpax	Dotaz
	Popis: CIR BRKR MAG-HYDR LEVER		
	Část#: IEG1-33079-1-V	Výrobci: Sensata Technologies, Airpax	Dotaz
	Popis: CIR BRKR MAG-HYDR LEVER		
	Část#: IEG1-33598-4-V	Výrobci: Sensata Technologies, Airpax	Dotaz
	Popis: CIR BRKR MAG-HYDR LEVER		
	Část#: IEG1-33079-2-V	Výrobci: Sensata Technologies, Airpax	Dotaz
	Popis: CIR BRKR MAG-HYDR LEVER		
	Část#: IEG1-34125-5-V	Výrobci: Sensata Technologies, Airpax	Dotaz
	Popis: CIR BRKR MAG-HYDR LEVER		
	Část#: IEG1-34125-1-V	Výrobci: Sensata Technologies, Airpax	Dotaz
	Popis: CIR BRKR MAG-HYDR LEVER		
	Část#: IEG1-33295-2-V	Výrobci: Sensata Technologies, Airpax	Dotaz
	Popis: CIR BRKR MAG-HYDR LEVER		
	Část#: IEG1-34165-R5-V	Výrobci: Sensata Technologies, Airpax	Dotaz
	Popis: CIRCUIT BREAKER MAG-HYDR LEVER		
	Část#: IEG1-34124-1-V	Výrobci: Sensata Technologies, Airpax	Dotaz
	Popis: CIR BRKR MAG-HYDR LEVER		
	Část#: IEG1-33568-12R5-V	Výrobci: Sensata Technologies/Airpax	Dotaz
	Popis: CIR BRKR MAG-HYDR LEVER		
	Část#: IEG1-33295-1-V	Výrobci: Sensata Technologies, Airpax	Dotaz
	Popis: CIR BRKR MAG-HYDR LEVER		
	Část#: IEG1-34125-4-V	Výrobci: Sensata Technologies, Airpax	Dotaz
	Popis: CIR BRKR MAG-HYDR LEVER		
	Část#: IEG1-33254-5-V	Výrobci: Sensata Technologies, Airpax	Dotaz
	Popis: CIR BRKR MAG-HYDR LEVER		

Související klíčová slova pro IEG1-33598-5-V

Sensata Technologies, Airpax IEG1-33598-5-V.	IEG1-33598-5-V distributor	IEG1-33598-5-V dodavatel	IEG1-33598-5-V Cena
IEG1-33598-5-V Stáhnout datasheet.	IEG1-33598-5-V Datasheet.	IEG1-33598-5-V Stock.	koupit IEG1-33598-5-V.
Sensata Technologies, Airpax IEG1-33598-5-V.	Sensata Technologies/Airpax IEG1-33598-5-V.		